

Varenummer: 20055552
 Beskrivelse: E+G Kobling for radial forskydning
 GN 240-M10x1,25-B

Mål

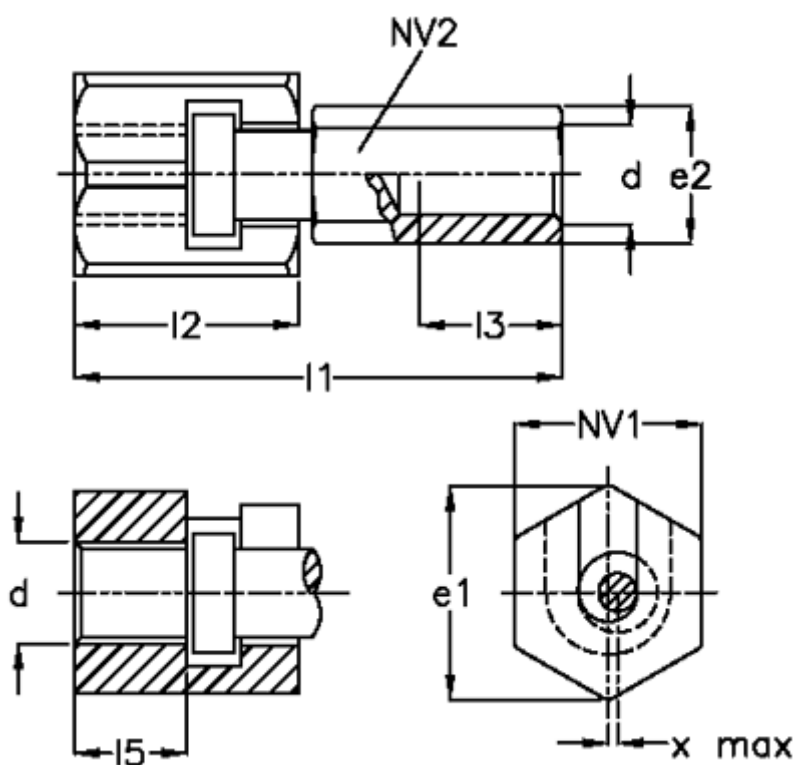

d	= M 10x1,25	Max træk-skub kraft N = 6500
e1	= 30.0	NV 1 = 27
e2	= 19.0	NV 2 = 17
l1	= 56.0	
l2	= 29.0	
l3	= 16.0	
l5 +1	= 16.0	
Max forskydning = 0.7		